

NEW BASE WITH ADAPTORS FOR INDUSTRIAL PUMPS



**ADVANCED
FLUID
MANAGEMENT
SOLUTIONS**





NEW BASE WITH ADAPTORS FOR INDUSTRIAL PUMPS

P/N 21/160-55

Anodized aluminum base for industrial pumps connection to bulk containers.

Thread fluid outlet 3"NPT.

There are 5 different adaptors to fix the pump to the base.

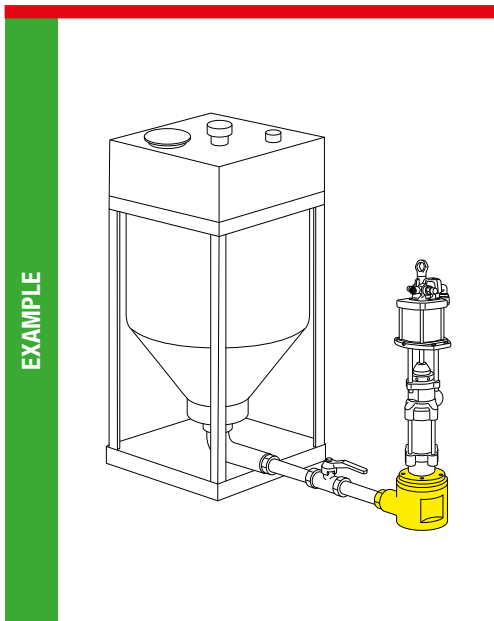
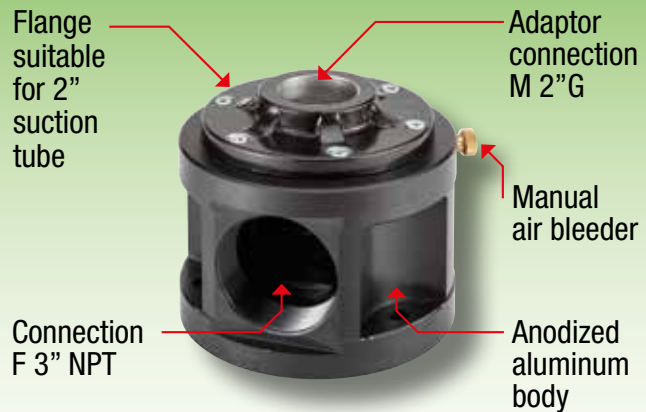

P/N 21/161-55

Industrial pump base with adaptor for suction tube F 1"

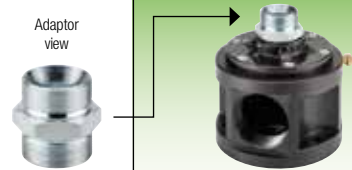

P/N 21/162-55

Industrial pump base with adaptor for suction tube F 2"

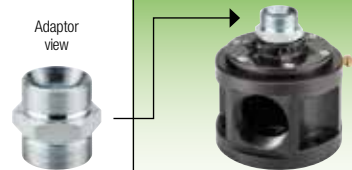

P/N 21/164-55

Industrial pump base with adaptor for suction tube Ø 1.77"

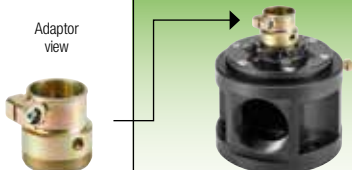

P/N 21/165-55

Industrial pump base with adaptor for suction tube Ø 2"

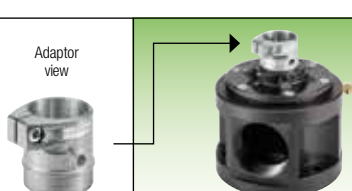

P/N 21/166-55

Industrial pump base with adaptor for suction tube Ø 2.09"

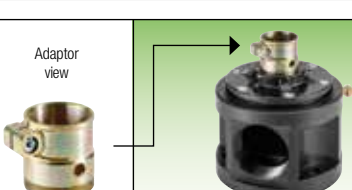

application fields



Mining



Industry



Chemical